

REV.	DATE	REVISIONS DESCRIPTION	REV. BY:

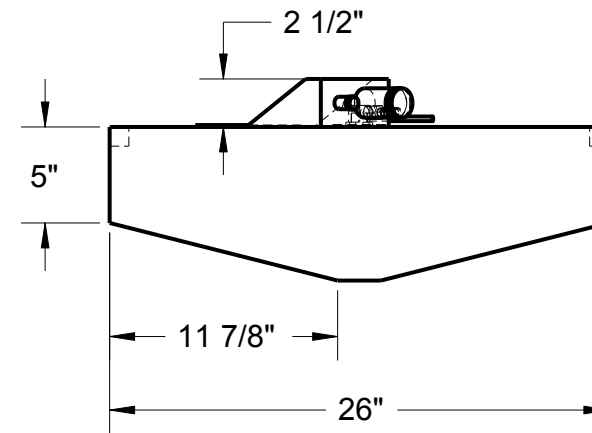
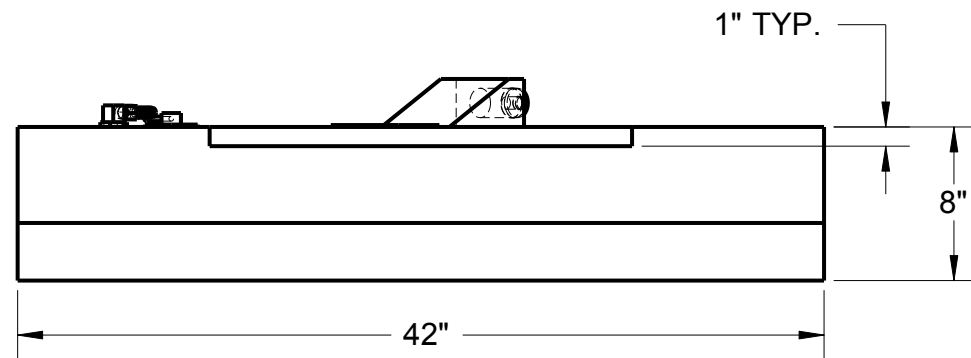
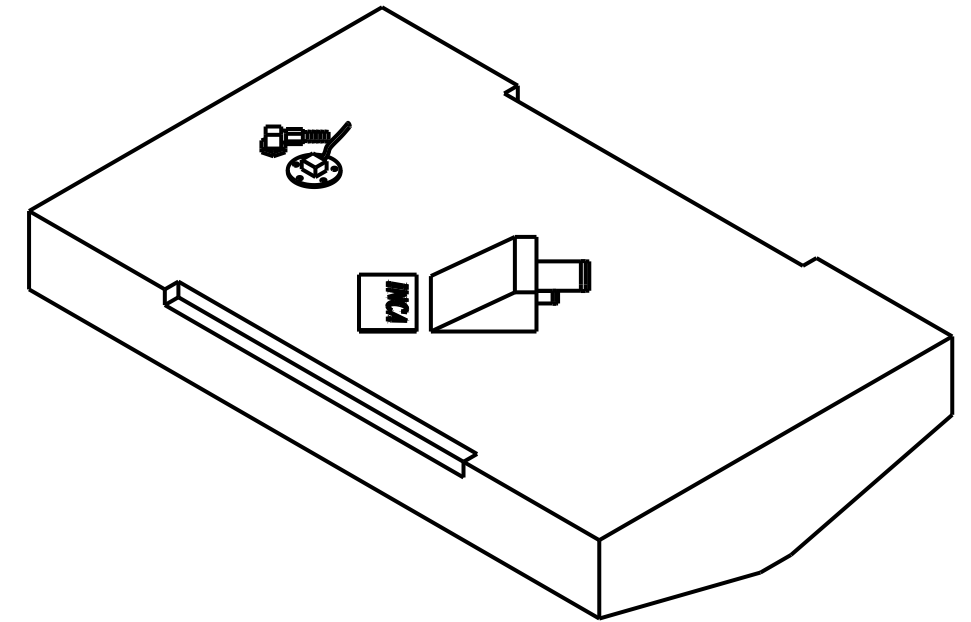
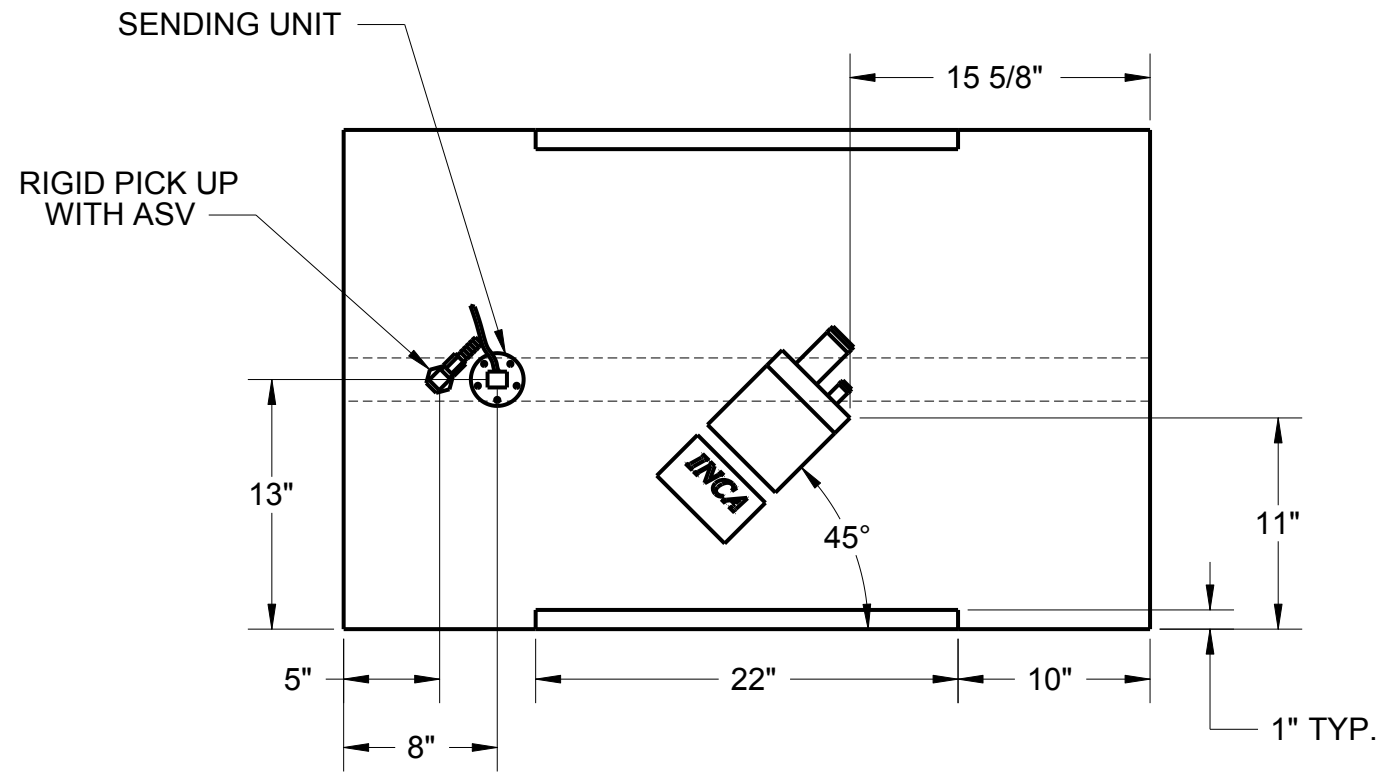

NOTE: PLASTIC FUEL TANKS MUST HAVE SPACE IN TANK COMPARTMENT TO EXPAND 2% FREELY IN ALL DIRECTIONS (LENGTH, WIDTH AND HEIGHT).

UNLESS NOTED OTHERWISE:  
 1) All dimensions in inches  
 2) All corner radii to be 3/8"

**MAT'L:** Polyethylene, Crosslink, Natural  
**WALL THICKNESS:** .210 in. (nominal)

**INCA**  
 MOLDED PRODUCTS, INC.

INCA MOLDED PRODUCTS, INC.  
 6400 LOUISIANA AVENUE  
 NASHVILLE, TN 37209 USA  
 (615) 350-7290

FUEL TANK, 31 GAL.

SHEET	1 of 1	
REV. DATE:		
CHECKED BY:		
DRAWN BY:	6/20/06	BR

Copyright by Inca Molded Products, Inc.  
 Nashville, TN 37209 USA



SCALE:    REVISION:  
                   A

**FO3138**