

REV.	DATE	REVISIONS DESCRIPTION	REV. BY:

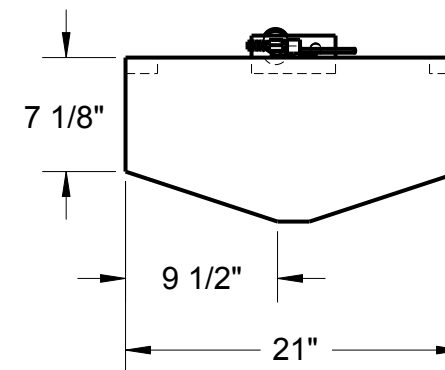
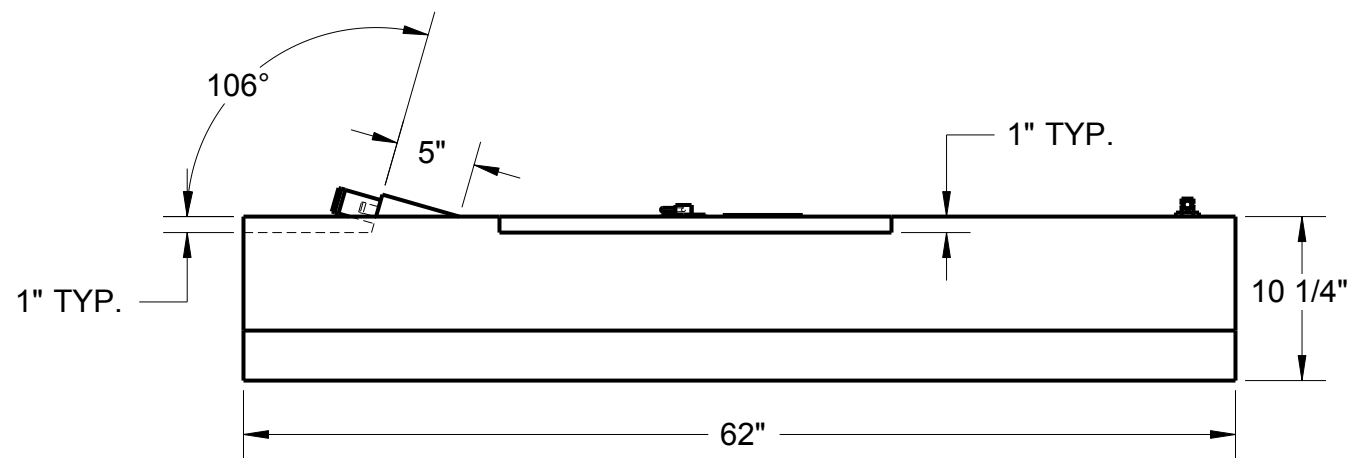
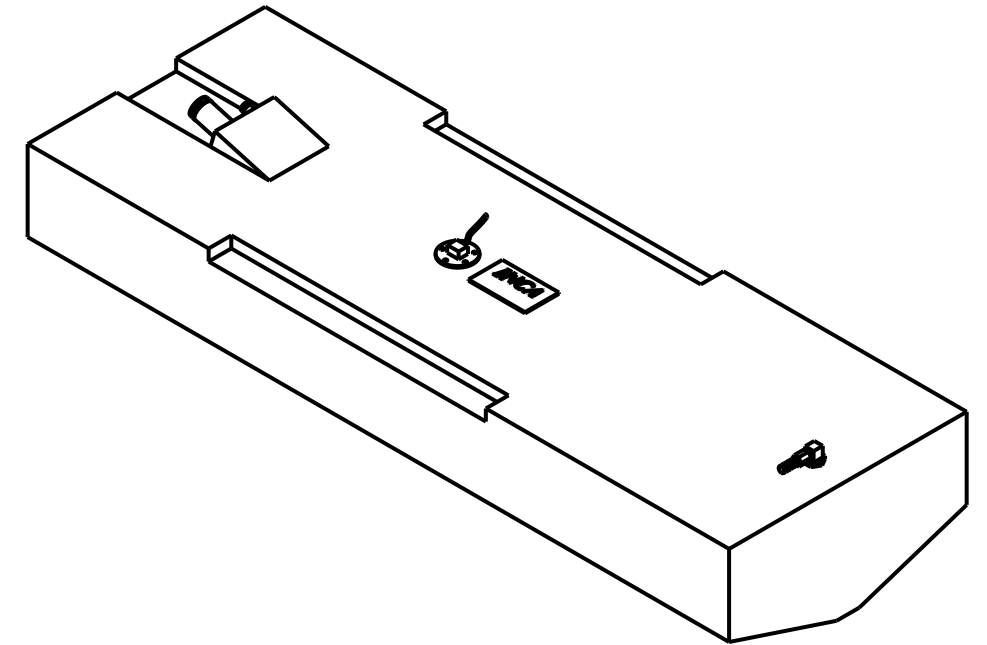
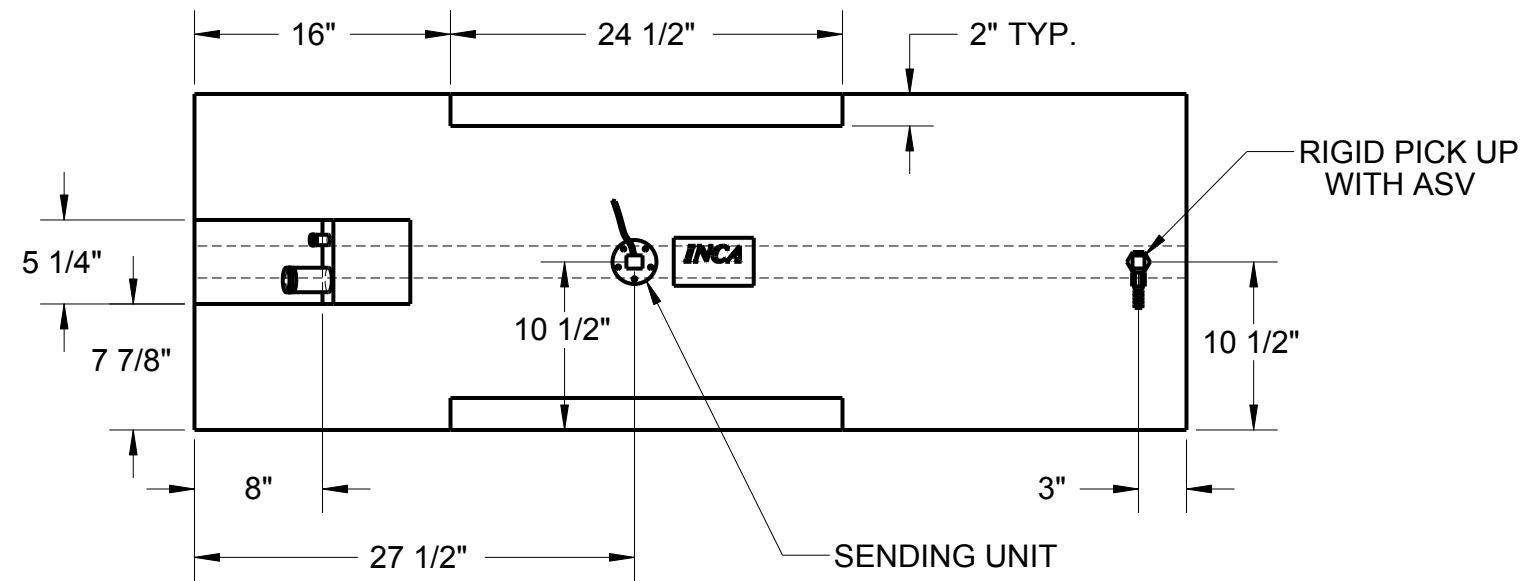

NOTE: PLASTIC FUEL TANKS MUST HAVE SPACE IN TANK COMPARTMENT TO EXPAND 2% FREELY IN ALL DIRECTIONS (LENGTH, WIDTH AND HEIGHT).

UNLESS NOTED OTHERWISE:  
 1) All dimensions in inches  
 2) All corner radii to be 3/8"

**MAT'L:** Polyethylene, Crosslink, Natural  
**WALL THICKNESS:** .225 in. (nominal)

**INCA**  
 MOLDED PRODUCTS, INC.

INCA MOLDED PRODUCTS, INC.  
 6400 LOUISIANA AVENUE  
 NASHVILLE, TN 37209 USA  
 (615) 350-7290

FUEL TANK, 42 GAL.

SHEET	1 of 1
REV. DATE:	
CHECKED BY:	
DRAWN BY:	6/27/06 BR

Copyright by Inca Molded Products, Inc.  
 Nashville, TN 37209 USA



SCALE: REVISION:  
 A

**FO4228**