

REV.	DATE	REVISIONS DESCRIPTION	REV. BY:

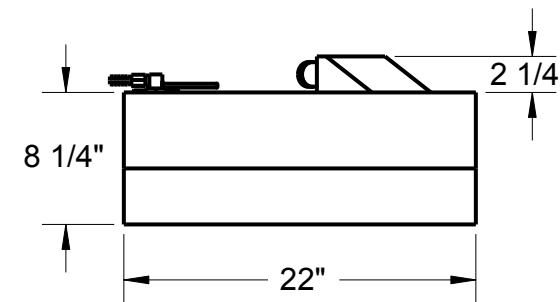
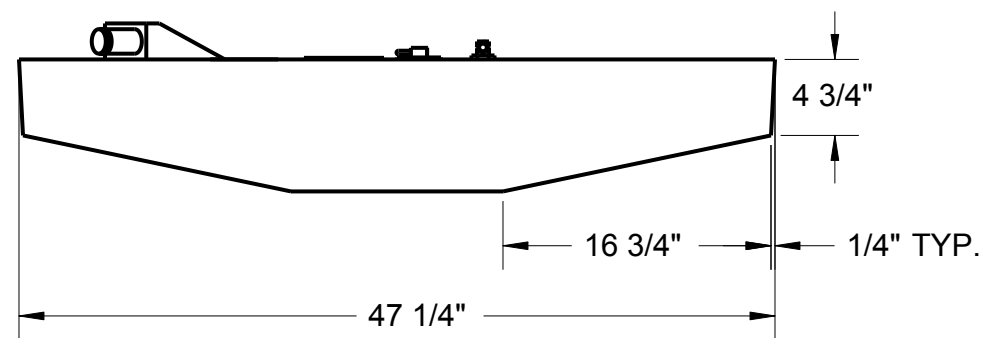
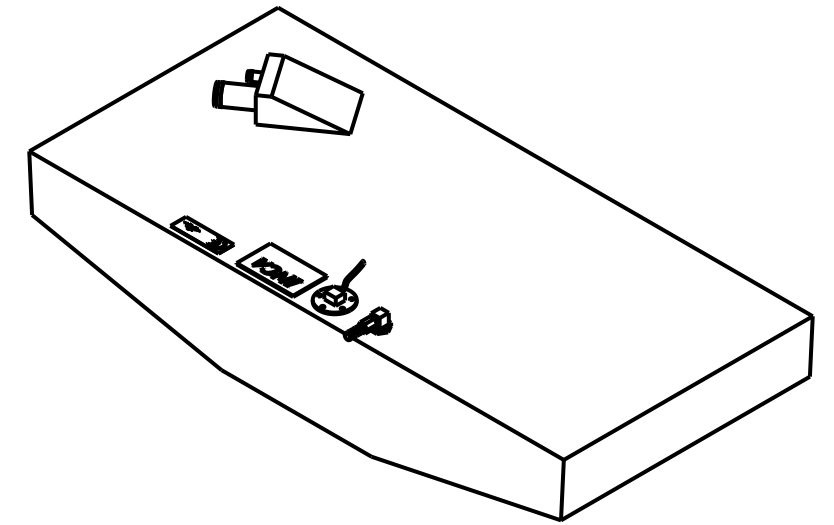
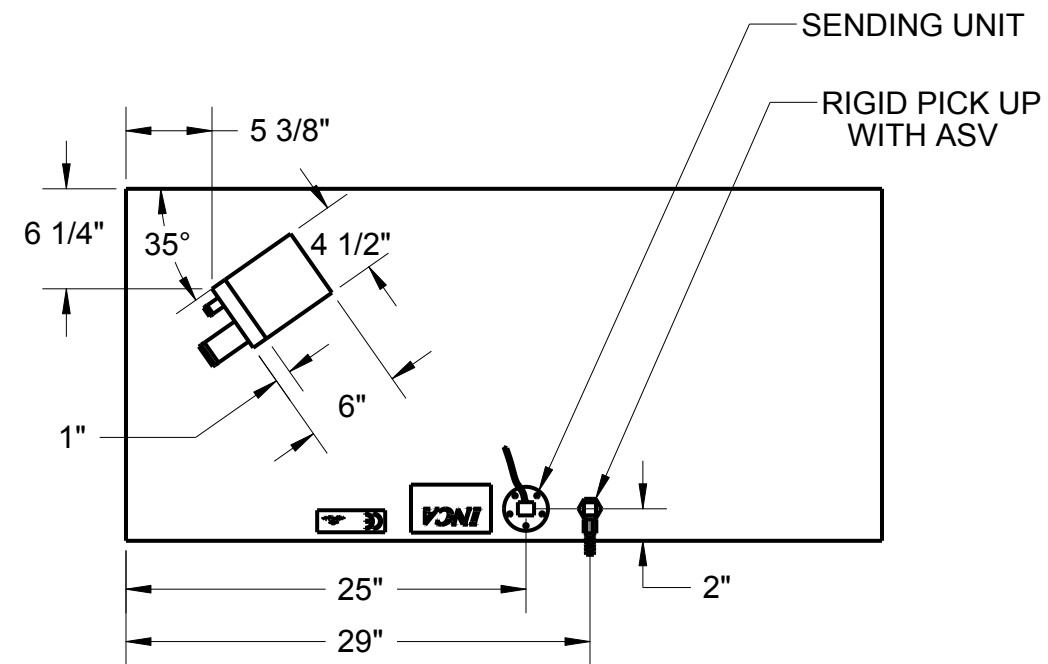

NOTE: PLASTIC FUEL TANKS MUST HAVE SPACE IN TANK COMPARTMENT TO EXPAND 2% FREELY IN ALL DIRECTIONS (LENGTH, WIDTH AND HEIGHT).

UNLESS NOTED OTHERWISE:
1) All dimensions in inches
2) All corner radii to be 3/8"

MAT'L: Polyethylene, Crosslink, Natural
WALL THICKNESS: .210 in. (nominal)

INCA
MOLDED PRODUCTS, INC.

INCA MOLDED PRODUCTS, INC.
6400 LOUISIANA AVENUE
NASHVILLE, TN 37209 USA
(615) 350-7290

FUEL TANK, 29 GAL.

SHEET 1 of 1

REV. DATE:

CHECKED BY:

DRAWN BY: 6/27/06 BR

Copyright by Inca Molded Products, Inc.
Nashville, TN 37209 USA



SCALE: REVISION:
A

FO2928