

REV.	DATE	REVISIONS DESCRIPTION	REV. BY:

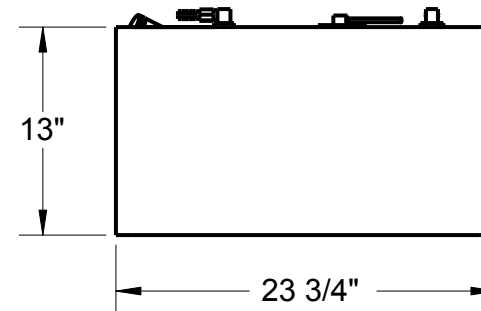
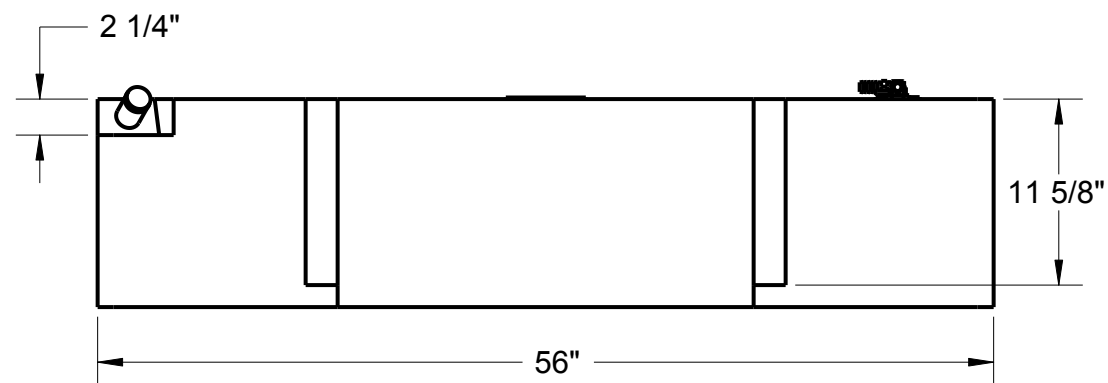
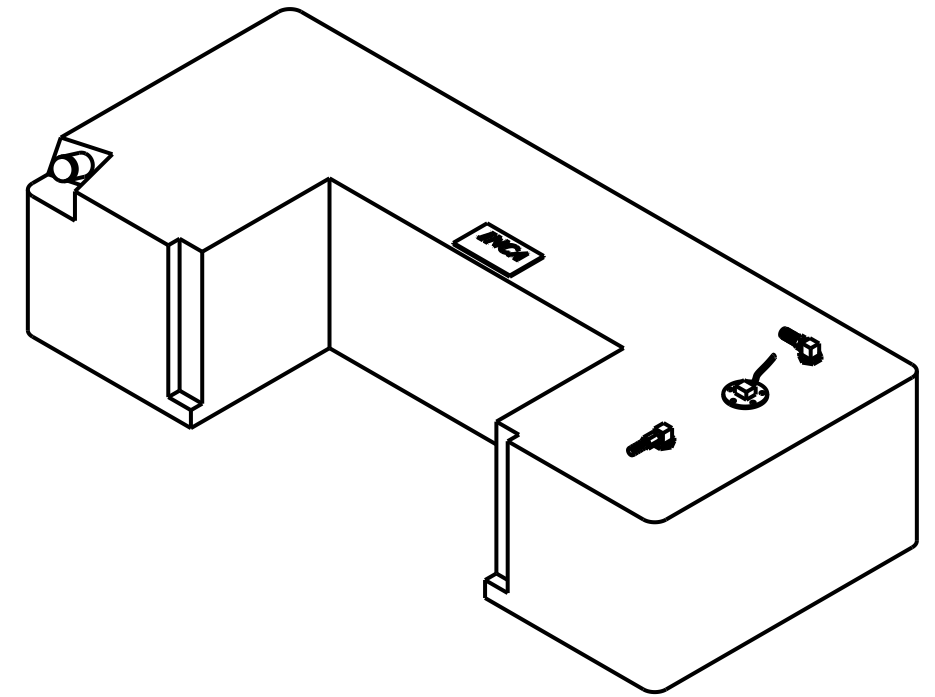
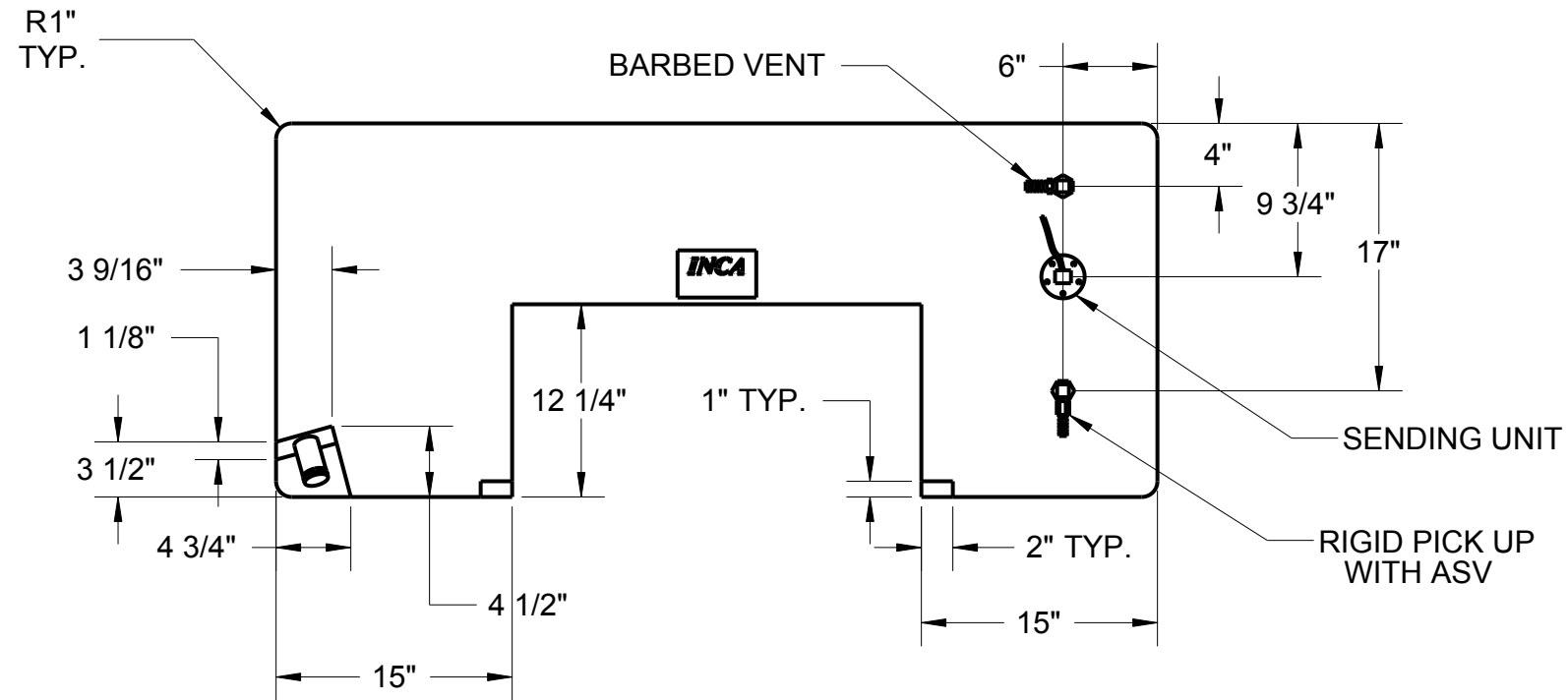

NOTE: PLASTIC FUEL TANKS MUST HAVE SPACE IN TANK COMPARTMENT TO EXPAND 2% FREELY IN ALL DIRECTIONS (LENGTH, WIDTH AND HEIGHT).

UNLESS NOTED OTHERWISE:
 1) All dimensions in inches
 2) All corner radii to be 3/8"

MAT'L: Polyethylene, Crosslink, Natural
WALL THICKNESS: .225 in. (nominal)

INCA
 MOLDED PRODUCTS, INC.

INCA MOLDED PRODUCTS, INC.
 6400 LOUISIANA AVENUE
 NASHVILLE, TN 37209 USA
 (615) 350-7290

FUEL TANK, 50 GAL.

SHEET 1 of 1

REV. DATE:

CHECKED BY:

DRAWN BY: 7/6/06 BR

Copyright by Inca Molded Products, Inc.
 Nashville, TN 37209 USA



SCALE: REVISION:
 A

FO5018